

# HARMONIE 3V EcoDesign

# PANADERO

## WYMIARY

WYS.xSZER.xGŁ.	889x796x482 mm
WAGA BRUTTO/NETTO	160/150 kg
WYMIARY DRZWIČEK	620x286 mm
WYLOT SPALIN	Ø 150-153 mm
	Pionowy

## CHARAKTERYSTYKA

RUSZT ŹELIWNY	
WIDOK OGNIĄ Z TRZECH STRON	
KORPUS ZE STALI	5 mm
MOC NOMINALNA	7,2 KW
SPRAWNOŚĆ	77 %
EMISJA CO	0,10 %
FARBA ŹAROODPORNĄ	800°C
SZYBA SZKLANO-CERAMICZNA	750°C

EAN 8426964184105  
REF. 18410

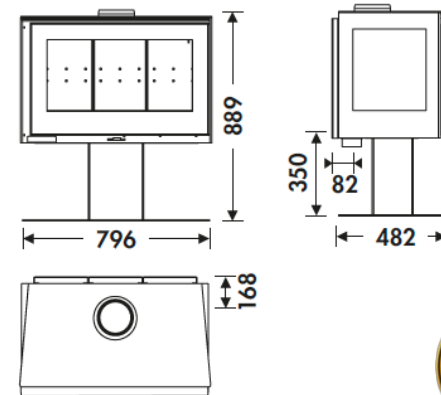

## ZALETY PRODUKTU

### ECODESIGN

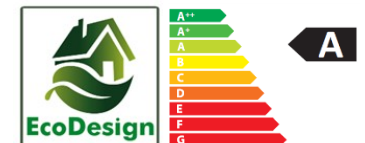
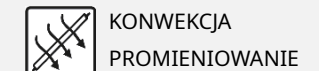
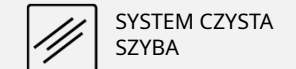
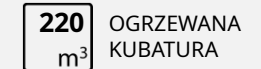
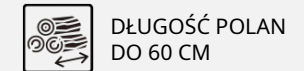
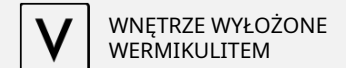

HARMONIE.PL